

Spherical roller bearings, cylindrical and tapered bore

Principal dimensions			Basic load ratings		Speed ratings		Designation
d	D	B	dynamic C	static C0	Reference speed	Limiting speed	
mm			kN		r/min		
<b>260</b>	440	180	3086	4800	670	950	<b>* SKF Explorer bearing</b> 24152 CCK30/W33 *

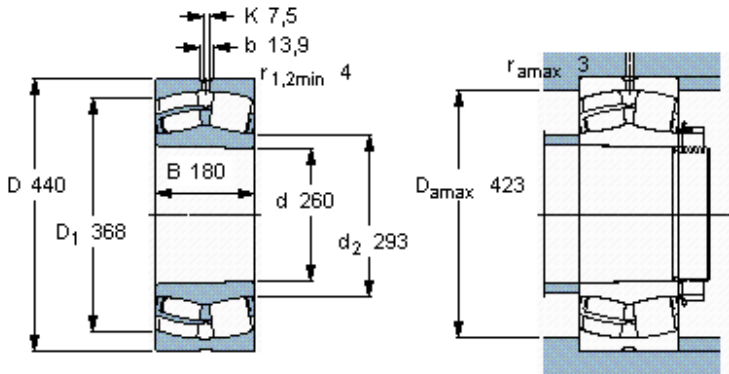

Tapered bore, taper  
1: 30

**Calculation factors**

- e 0,4
- $Y_1$  1,7
- $Y_2$  2,5
- $Y_0$  1,6